

V 5 0 0 D S

User Manual

V500DS

Digital Enhanced Cordless Communications

Depending on different models, not all features may be available in this general manual.

Contents

Introduction.....	3
■ Overview	3
■ Features	3
Installation and Basic Functions	5
■ Package Content	5
■ The Handset and Base Unit at a glance.....	6
■ How to Install the Base	7
■ How to Install the Handset	7
■ Important Safety Information	8
■ Getting Started with Skype.....	9
■ Adding Contacts.....	13
■ Making and Answering Calls	14
Advanced Functions	19
■ Menu Structure of V500DS.....	19
■ Skype Settings	21
■ Phone Settings	25
■ Resetting the System	32
■ Contacts.....	33
■ Handling Calls.....	35
Troubleshooting	36
Technical Details.....	39
Declaration of Conformity.....	40

Introduction

■ Overview

Thank you for purchasing our Skype DECT product. We hope that you spend many happy hours in using it and chatting with Skype! With the V500DS you can make landline calls and Internet calls using Skype™, SkypeOut and SkypeVoice mail.

- A landline call is a call between two telephone line subscribers.
- A Skype™ call is between two registered Skype™ users. These calls are free of charge.
- A SkypeOut call is made via the Internet to an ordinary telephone number anywhere in the world using the Skype™ software.
- Skype Voice mail allows you to send and receive voicemail messages and record a greeting.

This user manual will help you get the most out of handling the different calls and learning how to navigate the handset menu.

■ Features

Key Features

- Access Skype network without even turning on the PC
- Proven DECT technology to deliver clear digital communication
- Incorporate most of Skype feature like Voicemail, Call Forwarding, SkypeOut/In services
- Dual-phone: Calling on Skype and PSTN is on the same handset
- Handsfree Speakerphone / LCD Backlight / Keypad Backlight enhanced features

Call Features

- 1.5" color LCD with Skype GUI
- Skype buddy list
- SkypeOut/In support
- Call forwarding from Skype to PSTN
- Skype Voicemail

- Call Waiting
- Skype User profile
- Handsfree Speakerphone
- LCD backlight

Installation and Basic Functions

■ Package Content

The contents of your product should contain the following items. For any missing items, please contact your dealer immediately.

- 1 cordless V500DS handset
- 1 V500DS base
- 1 power supply for the base station
- 1 Ethernet cable
- 1 telephone cable
- 2 batteries (AAA; rechargeable)
- 1 User Manual
- 1 Easy Start Guide

■ The Handset and Base Unit at a glance

Left Key

Press to enter menu and sub-menu mode;
Press to confirm selection;
With the key “*” to lock or unlock the keypad;

Call / Recall Key

Press to begin and answer a telephone call.
You can activate Recall function if your phone is connected to a PABX, or if you use Select Services.
Press to transfer an outside

Scrolling Button

Press during programming to move through the menu;
Press during a call to change the volume in the earpiece.

Speakerphone Key

Press to turn the speakerphone ON/OFF

Charge Light

The CHARGE light comes on when the handset's batteries are being charged.

 Note: Before you can use the handset to make calls for the first time, you will need to fit and fully charge the batteries for 15 hours.

Right Key

Press to enter phonebook menu;
Press during programming to go back to the previous option;
Press to clear digits from the display.

End /On-Off Key

Press to end a telephone call.
Press and hold 2-3 seconds to switch the handset on / off ;

INT Key

Press to make an intercom call (if you have more than one handset).

Handset Locator Button

Press this to make the handset ring, if you cannot remember where you put it, press it again to stop the handset ringing.

Network Light

The Network light comes on when you have a connection to the Ethernet.

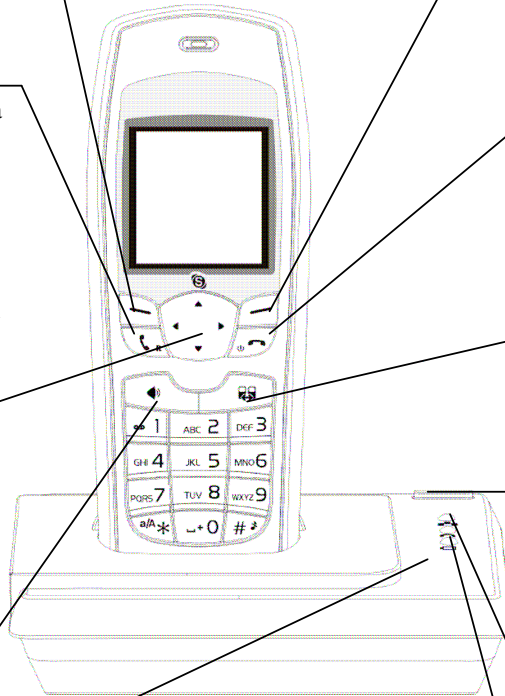

In Use Light

The IN USE light comes on when you place calls.

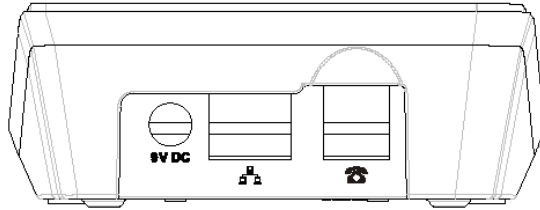

■ How to Install the Base



1. Connect  on the base to a LAN (Local Area Network) port on your broadband connection (modem, router, hub, switch etc.) using the provided Ethernet cable.
2. Connect the power adapter to an active power outlet and connect the power port on the base to the power adapter (9V, 500 mA).
3. Connect  on the base to a telephone socket (if available) using the provided telephone cable.

■ How to Install the Handset

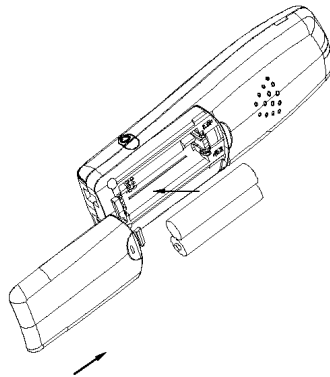

1. Push the top of the battery compartment cover on the back of the handset downwards.
2. Insert the two batteries provided with the handset making sure that their plus and minus ends are facing the same way as shown in the illustrations on the sides of the battery compartment.
3. Slide the battery compartment cover shut.

■ Important Safety Information

People with a heart pacemaker should consult their doctor before using the telephone.

If you wear a hearing aid, you should note V500DS works by transmitting radio waves between base and handset that may cause a humming noise.

1. **DO NOT** clean any part of your phone with benzene, thinner or other solvent chemicals, which may cause permanent damage to your phone. This damage is not covered by the Guarantee. When necessary, clean it with a damp cloth. Cleaning it with a wet cloth may give you an electric shock.
2. **DO NOT** use this equipment in places where volatile or explosive materials may be present.
3. **DO NOT** let the base unit get wet. Electrical equipment can cause serious injury if used while you are wet or standing in water. **NEVER** use your phone during a thunderstorm. Unplug the base unit from the telephone line and the mains socket when there are storms in your area. Damage caused by lightning is not covered by the Guarantee.
4. The V500DS will produce a certain amount of heat during operation. For this reason it is recommended that this equipment is **NOT** placed in direct contact with antique, veneered or delicate furniture surfaces.
5. **DO NOT** dispose batteries with normal household waste, never burn them, or put them where they could get punctured.
6. The V500DS DECT phone emits radio signals which could interfere with other electronic equipment, computers, radio, TV set, clock radio alarms, etc. A distance of at least one meter should be maintained between V500DS base station and other equipment. This will minimize the risk of such interference.
7. When you do not need to carry your handsets around, leave them on the base unit or charger pod, to keep the batteries charged.
8. If you hear a warning tone as move around during a call, and/ or the sound in the earpiece becomes faint or distorted; you may be going out of range of the base unit. Move nearer to the base unit within 20 seconds, until the tone stops. Otherwise your call may be cut off.
9. The base unit should be placed on a level surface, in a position where:
 - The mains adapter plug will reach a 230 V AC switched mains supply socket; never try to lengthen the mains power cable.
 - The telephone cable will reach your telephone line socket or extension socket.
 - It is not close to another telephone, this can cause radio interference.

- It is not close to a sink, bath or shower, or anywhere else where it might get wet.
- It is not close to other electrical equipment, fridges, washing machines, microwave ovens, TVs, fluorescent lights, etc.









Caution! Risk of explosion if an incorrect type replaces battery. Dispose of used batteries according to the instructions.

■ Getting Started with Skype



You can configure your V500DS with an existing Skype account during the first-time installation or you can optionally create a new Skype account. You only need a Skype username and password defined by you to create a new account.

Create a New Skype Account

If you do not have a Skype account, follow the instruction below:

1. In standby mode, press Right  key to enter Sign-in page;
2. Use Scrolling  button up / down to highlight **Create new account**, press Left  key to select this item;
3. Use keypad to enter the Skype name, press Right  key to clear the incorrect character, press Left  key to confirm your input.
4. Use keypad to enter the password, press Right  key to clear the incorrect character, press Left  key to confirm the input, you are asked to repeat the password by entering it again.
5. You are then directed to the Skype Agreement, use Scrolling  button up / down to read the entire text, then press Left  key to accept.









Notes:

- Press  key continuously to switch between the input methods, abc (lower case), ABC (upper case), 123 (digit), Abc (all).
- Press  button to input punctuation marks when entering your Skype account.
- Skype names can be 6 to 32 characters. You can use any mix of upper and lower case characters, numbers and punctuation marks. You cannot use spaces and your name cannot begin with a number or punctuation mark. If the name is already in use, you will be prompted to try another name.

- Password can be 4 to 20 characters. You can use any mix of upper and lower case characters, numbers and punctuation marks. Your password cannot begin with a number or punctuation mark, and it cannot be the same as your Skype name.
- Please be patient as the creation of your Skype account may take several minutes to perform.

To Sign in to Skype

When you already have a Skype account, you can sign in to Skype directly.



1. In standby mode, press Right  key to enter Sign-in page;
2. Use Scrolling  button up / down to highlight **Sign in to Skype**, press Left  key to select the entry;
3. Use keypad to enter the Skype name, press Right  key to clear the incorrect character, press Left  key to confirm your input.
4. Use keypad to enter the password, press Right  key to clear the incorrect character, press Left  key to confirm the input;
5. You are now asked whether you want to save your Skype name and password for automatic sign-in, press Left  key to accept, Right  key to decline.



Notes:

- Skype does not allow emergency calls. Such calls are always routed to the landline connection. Therefore it is important that you set the correct landline country. Do not forget that your V500DS has to be connected to a power outlet in order to work. Your V500DS will not function during a power failure.
- For input methods please refer to the notes of **Create a New Skype Account**.
- Please be patient as synchronization of Skype contacts might take several minutes.
- If you have accepted the automatic sign-in, the account will sign in without any prompting every time. For signing in another account, please refer to **To Choose Auto or Manual Sign In**.

To Sign out of Skype















If you do not want to use Skype functions or you would like to sign in another Skype account, you should sign out the current Skype account.

1. In standby mode, press Left  key to enter the main menu.
2. Use Scrolling  key up / down and Left  key to select *Status*;

3. Use Scrolling  key up / down and Left  key to select *Sign out*;
4. Press Left  key again to confirm your choice.









Main Display



Radio Signal Status	Indicates the strength of the radio signal.  Radio signal level.  No radio signal.
Battery Status	Indicates the status of the battery.  Low level.  Partially charged.  Fully charged.  Charging.
Skype Online Status	 Online  Skype Me  Away  Not Available  Do Not Disturb  Invisible  Offline
Current Time	Shows the current time you set.
Skype Credit	Your current Skype credit balance.
 Action	Left soft key Selects the current menu item or confirms a setting, depending on the current screen.





 Action	Right soft key Cancels the last action or returns to the previous screen, depending on the current screen.
--	--

More notification symbols sometimes displaying on the V500DS LCD:





	Missed calls
	New voicemail
	Exchange contact details request.
	Silent mode is active.
	Headset connected.
	Keypad locked.
	Skype credit is nearly expiry.
	The speakerphone is on.



Main Menu

The Main Menu provides all your Skype and V500DS settings.

1. In standby mode, press Left  key to enter the main menu.
2. Use Scrolling  key up / down to highlight one of the items, press Left  key to select, Right  key to go back to the standby mode.











The main menu table:

 Contacts	Your contact list and the current Skype status of your contacts.
 History	All calls, missed calls, incoming calls, outgoing calls, Landline calls, voicemails, contacts requests.
 Status	Change status, My profile, Sign out
 Add Contact	Adds a Skype user or a Skypeout number to your contact list.
 Search	Searches Skype users on line.







 Services	Allows you to view Skype credit, SkypeIn and Skype voicemail status.
 Settings	Settings for Network, General, Call divert, Privacy, Tones, Time and Date, Cordless Settings, Phone Settings and information.

■ Adding Contacts















To Add a Skype Contact

1. In standby mode, press Left  key to enter the main menu;
2. Use Scrolling  key up / down to highlight *Add Contact*, press Left  key to select;
3. Press Left  key to select *Skype*;
4. Use the keypad to enter the Skype name, press Right  key to delete incorrect characters before you press Left  key;
5. You are asked if you let the account you add to see you when you are on line, press Left  key to accept, press Right  key to decline.
6. The account has been added to your contacts list. Press Right  key to confirm, or press Left  key to accept to send an authorization request.
7. Press Left  key to send the authorization request.

To Add a SkypeOut Contact

1. In standby mode, press Left  key to enter the main menu;
2. Use Scrolling  key up / down to highlight *Add Contact*, press Left  key to select;
3. Press Scrolling  key up / down and Left  key to select *SkypeOut*;
4. Use the keypad to enter the full phone number for use with SkypeOut, press Right  key to delete incorrect characters before you press Left  key. SkypeOut numbers (even local numbers) must be entered in the following format: “+” followed by “country code”, “area code” and “number”.

To Search for a Skype User



1. In standby mode, press Left  key to enter the main menu;
2. Use Scrolling  key up / down to highlight *Search*, press Left  key to select;
3. Use the keypad to enter a Skype name or a full name or an email address, press Left  key to search; press Left  key again to stop or Right  key to cancel searching if needed.
4. The display shows all the matched accounts, use Scrolling  key up / down to highlight your preferred one, press Left  key to select;
5. Press Left  key to select *Add to contacts*.
6. You are asked if you let the account you add to see you when you are on line, press Left  key to accept, press Right  key to decline.
7. The account has been added to your contacts list. Press Right  key to confirm, or press Left  key to accept to send an authorization request.
8. Press Left  key to send the authorization request.

■ Making and Answering Calls

The procedures for making and receiving calls apply to any type of calls — Skype-to-Skype calls, SkypeOut calls and SkypeIn calls. Furthermore, you can use your phone for landline telephony.

In standby mode, press any button on keypad except “Talk” button to make the backlight come on before enabling any function. (It means 1st press to turn on the backlight, 2nd press to activate the function button. This is correct for all buttons except for “Talk” button.)

To Answer a Call



- Press the Call  key to answer call or
- Press Left  key to answer a call or
- When the AUTO TALK is turned on, you can simply answer the call by lifting the handset from the base unit (see *AUTO TALK* part).

You can turn the speakerphone on by pressing Speakerphone  key while answering calls; press this key again to turn the speakerphone off.

To Reject a Call

Press Right  key to reject a call before answering it.



To End a Call

- Press End  key or Right  key to hang up.





To Make a PSTN Call

Dial number from idle screen directly.

Use Left  key to place call:

1. Input the telephone number you want to dial, press Left  key;
2. Press Scrolling  button up / down and Left  key to select *Landline*.

Use Call  key to place call:

1. Input the telephone number you want to dial;
2. When your preferred line is set to *Always landline*, press Call  key to make a PSTN call directly;
when your preferred line is set to *Always ask*, press Scrolling  button up / down and Left  key to select *Landline*;
when your preferred line is set to *Always SkypeOut*, you can't use Call  key to place PSTN call. (Refer to **To Set the preferred line** for more information)

Note:



For Landline Calls, there is no prefix required, such as “+” or “00”, you can dial the number directly.



To Make a SkypeOut Call

SkypeOut allows you to use your Internet connection to call ordinary telephones and mobile telephones worldwide. Requires the SkypeOut service from Service Provider for landline calls first.



Dial number from idle screen directly.

Use Left  key to place call:



1. Press and hold  key until a “+” appears on the display, input the country code, then the telephone number, press Left  key;

2. Press Scrolling  button up / down and Left  key to select *SkypeOut*.

Use Call  key to place call:

1. Press and hold  key until a “+” appears on the display, input the country code, then the telephone number, press Call  key;









2. When your preferred line is set to *Always SkypeOut*, press Call  key to make a SkypeOut call directly;

When your preferred line is set to *Always ask*, press Scrolling  button up / down and Left  key to select Skypeout;





When your preferred line is set to *Always Landline*, you can't use Call  key to place SkypeOut call. (Refer to **To Set the preferred line** for more information)



To Call a Skype™ User

Make sure the Skype™ user is available in your Skype net Contact list and is online. Otherwise, add the online Skype™ user name you wish to call to the Contacts list first. It will automatically appear in your phone's Skype list. To call a Skype™ user:









1. In standby mode, press Left  key to enter the main menu; press Left  key to select *Contacts*, the display shows the stored names;
2. Or press Right  key to enter the Contacts menu in standby mode;
3. Press Scrolling  button up / down to highlight your preferred contact, press Left  key to select;
4. Press Left  key again to select *call*;
5. Press Scrolling  button up / down and Left  key to select your preferred number (**Skype, Mobile, Office, Home**).

To Make a Call from Contacts

1. In standby mode, press Left  key to enter the main menu;
2. Press Left  key to select *Contacts*, the display shows the stored names;
3. Press Scrolling  button up / down to highlight your preferred contact, press Left  key to select;
4. Press Left  key to select *Call*;

5. If you select a Skype account, press Left  key again to call; if you select a landline number, press Scrolling  button and Left  key to select *PSTN* or *SkypeOut*.











To Make a call from Call Logs

1. In standby mode, press Left  key to enter the main menu;
2. Press Left  key to select *History*, the display shows *All calls*, *Missed calls*, *Incoming calls*, etc;
3. Press Scrolling  button up / down to highlight your preferred call logs, press Left  key to select;
4. Press Scrolling  button up / down and Left  key to select the number you want to call;
5. Press Left  key to select *Call*;
6. When the selected log is a Skype account, press Scrolling  button up / down and Left  key to select your preferred number (**Skype, Mobile, Office, Home**).



Note:

You are also allowed to dial a landline number from the call logs by selecting Landline calls (Received call, Dialed call, Missed call) under History mode.





To make a call From Network

1. In standby mode, press Left  key to enter the main menu;
2. Press Scrolling  button up / down and Left  key to select *Search*;
3. Use the keypad to enter the full name or Skype name or email address you want to search, press Left  key to confirm;
4. The display shows all the matched accounts, use Scrolling  key up / down to highlight one, press Left  key to select;
5. Use Scrolling  key and Left  key to select *Call*.
6. Press Scrolling  button up / down and Left  key to select your preferred number (**Skype, Mobile, Office, Home**).

To Set Earpiece Volume

- During an active call, you just press Scrolling  button up/down to adjust the volume of the earpiece, press Left  key to confirm.

To Mute the Mouthpiece

1. Press Left  key during an active call;
2. Press Left  key to select *Mute microphone*, this prevents the person on the active call from hearing what you or someone else in the room is saying;
3. To cancel the Mute function, press Left  key during the active call, use Scrolling  button up/down and Left  key to select *Unmute microphone*

Advanced Functions

■ Menu Structure of V500DS

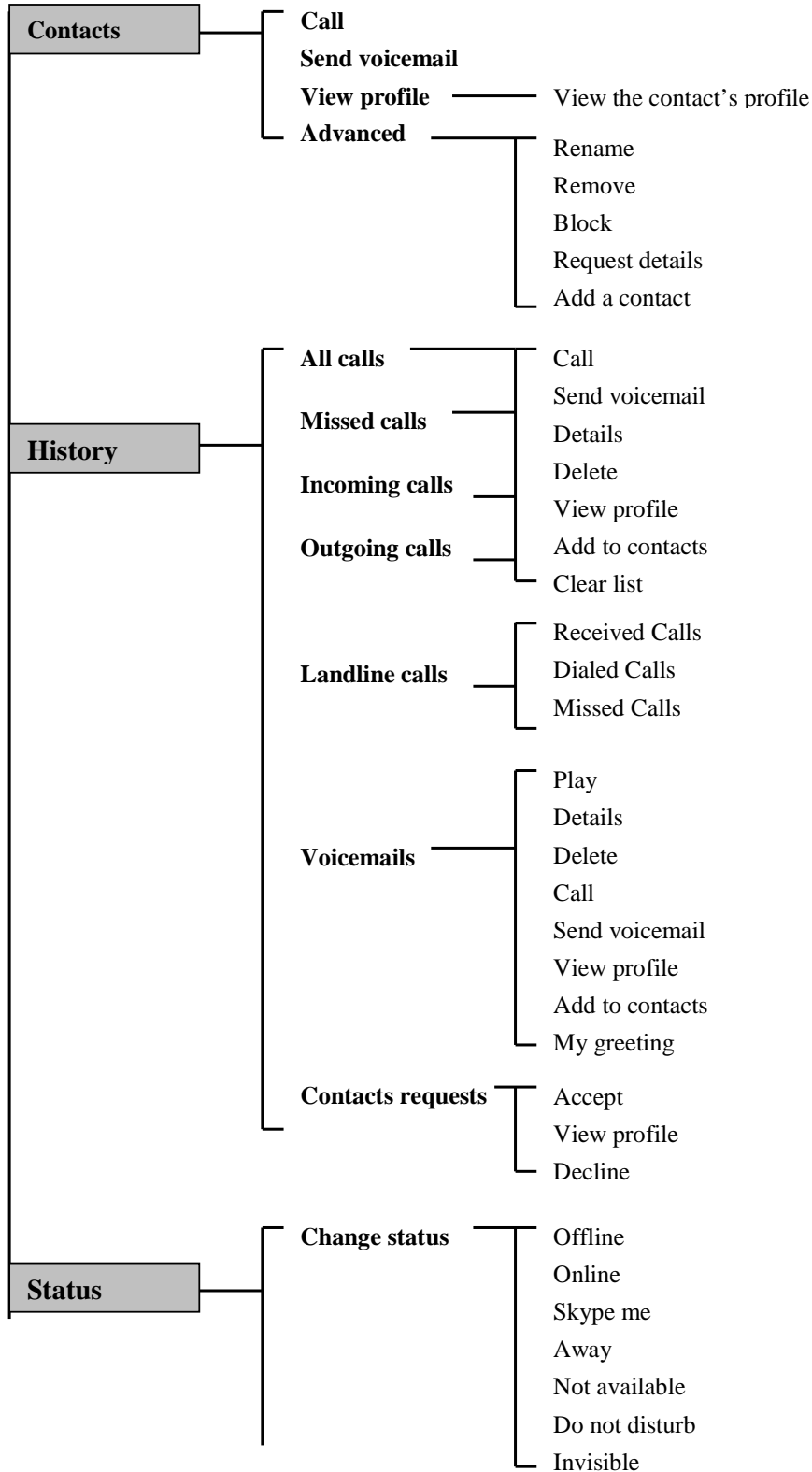

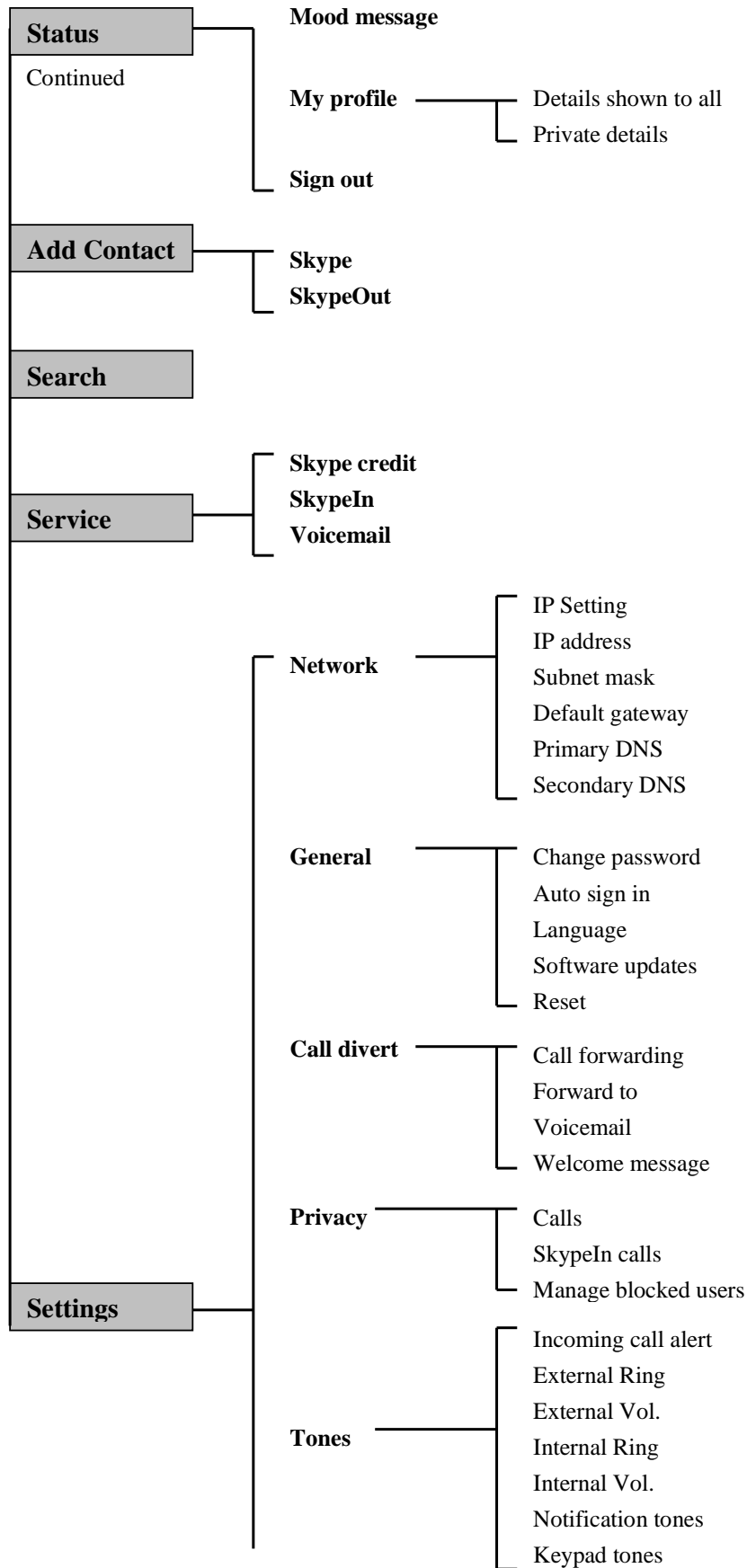

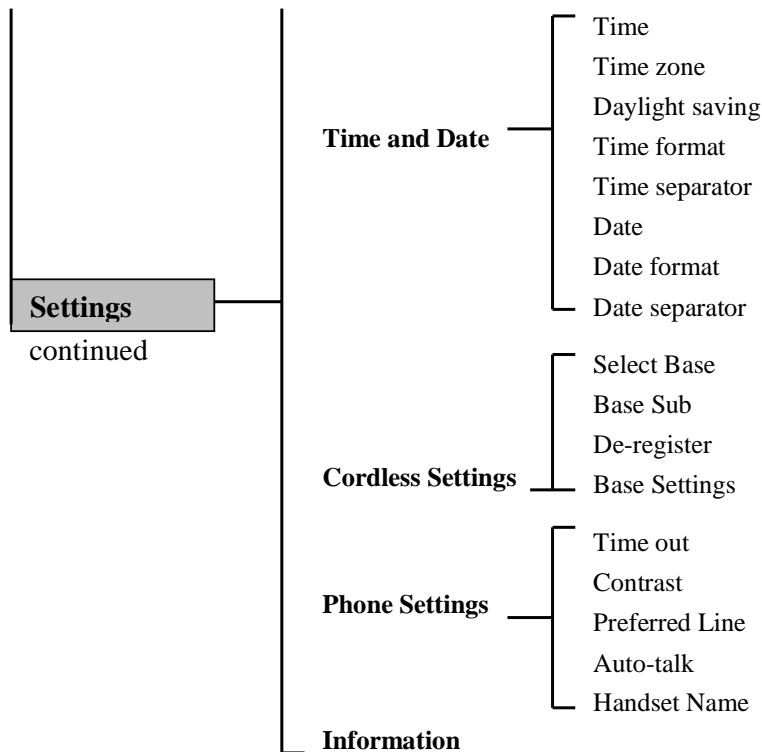









■ Skype Settings

To Change Your Online Status



















Your online status can be seen by all Skype contacts authorized by you. For more on this, please see **Main Display** in the **Installation and Basic Functions** section. For more on authorizations, please refer to **Exchange Contact Details Request** in this section of the manual.

1. In standby mode, press Left  key to enter the main menu; use Scrolling  key and Left  key to select *Status*; use Scrolling  key and Left  key to select *Change status*;
2. Or in standby mode, use Scrolling  up key to enter the Status menu;
3. Use Scrolling  key and Left  key to select your preferred status.

To Change Your Skype Profile





You must be signed into Skype to change your Skype profile.





1. In standby mode, press Left  key to enter the main menu;

2. Use Scrolling  key and Left  key to select *Status*;
3. Use Scrolling  key and Left  key to select *My Profile*;
4. Use Scrolling  key and Left  key to select your preferred profile (**Details shown to all, Private details**).
5. There are two modes for you to edit your profile:
 - In **Details shown to all**, press Scrolling  key and Left  key to select your preferred setting. (**Skype name, Full name, Gender, Birthdate, Country/Region, State/Province, City, Language, Home phone, Office phone, Mobile, Home page, About me**).
 - a) In **Skype name**, please note that you cannot change your Skype name here.
 - b) In **Full name**, use the keypad to enter your data.
 - c) In **Gender**, use Left  key to select (**Unspecified, male, female**).
 - d) In **Birthdate**, enter the date using the keypad, press Left  key to confirm.
 - e) In **Country/Region**, use Scrolling  key and Left  key or just Left  key to select (Afghanistan->Zimbabwe).
 - f) In **State/Province** and **City**, use the keypad to enter your data, press Left  key to confirm.
 - g) In **Language**, use Scrolling  key and Left  key or just Left  key to select (English->Chinese).
 - h) In **Home phone, Office phone, Mobile, Home page**, and **About me**, use the keypad to enter your data.
 - In **Private** you can enter your e-mail address. The address will not be shown to other Skype users and is merely used for the search function: Save your private e-mail address in **Private**, and users who know this address will be able to find you by searching for it on Skype.
 - a) In private, when there are existing email addresses press Left  key to select options (**edit, Remove, Add**).

To Change Your Password









You can change your Skype password here.

1. In standby mode, press Left  key to enter the main menu;
2. Use Scrolling  key and Left  key to select *Settings*;
3. Use Scrolling  key and Left  key to select *General*;

4. Use Scrolling  key and Left  key to select *Change password*;
5. Use the keypad to input the old password, press Left  key to confirm;
6. Use the keypad to input the new password, press Left  key to confirm;
7. Repeat the new password, press Left  key to confirm.









To Choose Auto or Manual Sign In

Your first sign-in has to be manual, but after that you can activate *Auto sign in* and sign in to your Skype account automatically, in case you should turn off the base station or the handset. If you activate prompt, you have to enter your Skype password every time you sign in.

1. In standby mode, press Left  key to enter the main menu;
2. Use Scrolling  key and Left  key to select *Settings*;
3. Use Scrolling  key and Left  key to select *General*;
4. Press Left  key to select *Auto sign in*;
5. Use Scrolling  key and Left  key or just Left  key to select your preferred sign-in mode. (**Automatically sign in, Prompt for password**)

To Create a Personal Voicemail Greeting

Skype voicemail has a default voicemail greeting. You can also create your personal welcome greeting, which will be played back to people calling you when you are unable to answer the call.













1. In standby mode, press Left  key to enter the main menu;
2. Press Scrolling  button and Left  key to select *Settings*;
3. Press Left  key to select *Call divert*;
4. Press Scrolling  button and Left  key to select *Welcome message*;
5. Press Left  key to enter the options;
6. Press Scrolling  button and Left  key to select *Record new*, and select *Play* to listen to the message.

Note:

You have to buy a Skype voicemail subscription to use this service. See more at www.skype.com.







To Listen to Your Voicemail

Callers can leave a message for you. Whenever someone sends you a voicemail, the message **You have 1 new voicemail** will be displayed on your V500DS

1. In standby mode, press Left  key to enter the main menu; press Scrolling  button and Left  key to select *History*; press Scrolling  button and Left  key to select *Voicemails*;
2. Or press  to enter Voicemail menu under standby mode;
3. Press Scrolling  button and Left  key or just Left  key to select the voicemail you desired to listen to;
4. Press Scrolling  button and Left  key or just Left  key to select one option (**Play, Details, Delete, Call, Send voicemail, View profile, Add to contacts, My greeting**).

To Set Privacy





You can specify which kinds of Skype and SkypeIn calls you want to accept.

1. Press Scrolling  button and Left  key to select *Settings* under main menu mode;
2. Press Scrolling  button and Left  key to select *Privacy*;
3. Press Left  key to select *Calls*, you are allowed to select *Anyone, Only my contacts, Only if details shared*. Press Scrolling  button and Left  key to select one you prefer.

Anyone: All Skype users can call you, even users not on your Contact list.

Only my contacts: Skype users can call you only if they are on your Contact list.





Only if details shared: Only Skype users authorized by you can call you.

4. Or press Scrolling  button and Left  key to select *SkypeIn calls*, you are allowed to select *Anyone, Known numbers, Only my contacts*. Press Scrolling  button and Left  key to select one you prefer.

Anyone: You can receive calls from anyone calling your SkypeIn number.











Known numbers: Only SkypeIn calls providing a Caller ID will be accepted.

Only my contacts: Only SkypeOut contacts on your Contact list can call you.

5. Or press Scrolling  button and Left  key to select *Manage blocked users*, you are allowed to view the blocked users. Press Scrolling  button and Left  key to unblock the user you prefer.

Notification

You can choose whether you want to be alerted by a tone whenever you receive a voicemail or an authorization request.







1. In standby mode, press Left  key to enter main menu;
2. Press Scrolling  button and Left  key to select *Settings*;
3. Press Scrolling  button and Left  key to select *Tones*;
4. Press Scrolling  button and Left  key to select *Notification tones*;
5. Press Scrolling  button and Left  key to turn notification tones on or just Left  key to turn them on.

■ Phone Settings

Internet Settings

You can configure settings such as IP Setting, IP address, Subnet mask, Default gateway, Primary DNS and Secondary DNS. However, if you have an advanced Internet connection and are not familiar with firewalls and ports, we recommend that you consult someone with knowledge on this or read more on the topic at www.skype.com.

In **IP Setting** you can choose **DHCP** (Dynamic Host Configuration Protocol) or **Static**. The DHCP IP setting covers the needs of most users. Should you wish to attach the base station to an Internet connection using the static IP mode instead, this is how to configure this mode below.





1. Press Scrolling  button and Left  key to select *Settings* under main menu mode;
2. Press Scrolling  button and Left  key to select *Network*;
3. Press Left  key to select *IP Setting*;
4. Press Scrolling  button and Left  key to select *Static*;

Now it is easy to set IP address, Subnet mask, Default gateway, Primary DNS and Secondary DNS here.

Tones

You can configure different kinds of tones on your V500DS.

To enter the Tones mode

1. In standby mode, press Left  key to enter main menu;
2. Press Scrolling  button and Left  key to select *Settings*;
3. Press Scrolling  button and Left  key to select *Tones*;

To Change the Incoming Call Alert





You can define how you want your V500DS to alert you with incoming calls:

Ringng: The handset will ring as long as the incoming call is active.





Ring once: The handset will ring only once.

Beep once: The handset will make one beep only on an incoming call.

Off: The handset will not make any voice on an incoming call.





1. Press Left  key to select *Incoming call alert* under Tones mode;
2. Press Scrolling  button and Left  key or just Left  key to select your preferred alert type. (**Ringng**, **Ring once**, **Beep once**, **Off**)

To Change the External Ring

1. Press Scrolling  button and Left  key to select *Incoming call alert* under Tones mode;
2. Press Scrolling  button and Left  key or just Left  key to select your preferred ring;







If you wish to set the *External Vol.*, *Internal Ring* and *Internal Vol.*, this is easily done here.

To Adjust the Keypad Tones

1. Press Scrolling  button and Left  key to select *Keypad tones* under Tones mode;
2. Press Scrolling  button and Left  key to turn the keypad tones off or just Left  key to turn the keypad tones on.

To Change the Handset Language

1. Press Scrolling  button and Left  key to select *Settings* under main menu mode;

2. Press Scrolling  button and Left  key to select *General*;
3. Press Scrolling  button and Left  key to select *Language*;
4. Press Scrolling  button up/down and Left  key to select your preferred language.

To Set the preferred line











You can configure how you want to route your outgoing calls when using Call  button.

These are your options:

Landline: Select this option if you always want to route your landline and/or mobile phone calls via the landline (traditional telephony).

SkypeOut: Select this option if you always want to route your calls to the landline and/or mobile phones via the Internet (SkypeOut).







Always ask: Select this option if you want to always be prompted to specify the preferred routing for a call

1. In standby mode, press Left  key to enter the main menu;
2. Press Scrolling  key and Left  key to select *Settings*;
3. Press Scrolling  key and Left  key to select *Phone settings*;
4. Press Scrolling  key and Left  key to select *Preferred Line*;
5. Press Scrolling  key and Left  key or just Left  key to select *Landline*, *SkypeOut* or *Always ask*

To Set the Time and Date

Your V500DS will always obtain time and date information from the Internet. Thus, you only have to configure the **time zone** and **Daylight saving** settings. When this is done, the time and date obtained by your V500DS from the Internet will be adjusted according to your choices.





To Set Time Zone

1. In standby mode, press Left  key to enter the main menu;
2. Press Scrolling  key and Left  key to select *Settings*;
3. Press Scrolling  key and Left  key to select *Time and Date*;
4. Press Scrolling  key and Left  key to select *Time zone*;

5. Press Scrolling  key and Left  key to select your preferred time zone;

To Set Daylight Saving

Choose Daylight saving when you are in a zone with summertime, and choose Standard in all other zones.





1. Repeat the step 1-3 above;
2. Press Scrolling  key and Left  key to select *Daylight saving*;
3. Press Scrolling  key and Left  key to select your preferred mode (Standard, Daylight saving).

If you wish to adjust the *Time format* and *Time separator* as well as the *Date format* and *Date separator* settings, this is easily done here.





Registration

Your V500DS is supplied with the handset already registered to the base unit; you shouldn't need to register it. But if you've bought extra handset, you'll need to register each one to your original base unit. Maximum 4 handsets can be registered to one base.

To Enter Registration Mode





1. Press Scrolling  button and Left  key to select *Settings* under *menu* mode;
2. Press Scrolling  button and Left  key to select *Cordless settings*, and the display shows *Select base, Base sub De-register* and *Base setting*.

To Register a Handset

1. Press and hold the **Handset locator** button on the base unit for a while, until you hear "beep" sound twice continuously;
2. Press Scrolling  button and Left  key to select *Base Sub* under *Cordless settings* mode, the display shows *BASE 1; BASE 2; BASE 3; BASE 4*;
3. Press Scrolling  button and Left  key to select the certain base;
4. Enter base PIN (0000), and press Left  key to confirm;
5. After registered, the handset goes back to the standby mode.





To Select a Base

You may need to do this if your handset has been registered to more than one base, and you need to select one to use.

1. Press Scrolling  button and Left  key to select *Select Base* under *Cordless settings* mode, the display shows *BASE 1; BASE 2; BASE 3; BASE 4;*
2. Press Scrolling  button and Left  key to select the certain base.

To De-register a Handset

You may need to do this if you have more than one handset registered to your base unit and you need to replace a faulty handset.







1. Press Scrolling  button and Left  key to select *De-register* under *Cordless settings* mode;
2. Key in the PIN (default 0000), press Left  key to confirm;
3. Then key in the number of the handset you want to de-register, press Left  key to confirm.

Note:



You cannot de-register the handset you are currently using.





To Set the Contrast





You can adjust the contrast of your display.

1. Press Scrolling  button and Left  key to select *Settings* under main menu mode;
2. Press Scrolling  button and Left  key to select *Phone settings*;
3. Press Left  key to select *Contrast*;
4. Press Scrolling  button up/down and Left  key to change the contrast.

Auto-talk Function

Normally, you need to press the Call  button to answer an incoming call. But with *AUTOTALK* function turned on, when your handset is ringing for an incoming call, you can answer the call by simply lifting the handset from the base unit without pressing the Call  button.









1. Press Scrolling  button and Left  key to select *Settings* under main menu mode;
2. Press Scrolling  button and Left  key to select *Phone settings*;

3. Press Scrolling  button and Left  key to select *Auto-talk*;
4. Press Scrolling  button and Left  key to select *Off / On*.

Note:

If you have turned Auto-talk on, do not press the Call  button after you've answered a call by lifting the handset, otherwise, you'll disconnect the call.

To Set Handset Name











1. Press Scrolling  button and Left  key to select Settings under main menu mode;
2. Press Scrolling  button and Left  key to select *Phone settings*;
3. Press Scrolling  button and Left  key to select *Handset Name*;
4. Enter the name of the handset, press Right  key to clear the incorrect character, then Left  key to save.

Base Settings

To Set Base Ringer

You are allowed to set the melody, volume of your V500DS base here.

To set Ringer Volume (1-9 melody)







1. Press Scrolling  button and Left  key to select *Settings* under main menu mode;
2. Press Scrolling  button and Left  key to select *Cordless settings*;
3. Press Scrolling  button and Left  key to select *Base settings*;
4. Press Left  key to select *Ringer Settings*;
5. Press Left  key again to select *Ringer Volume*;
6. Press Scrolling  button up/down to change the volume level, then press Left  key to confirm your setting.

If you wish to set the *Ringer Melody*, this is easily done here.

Dial Settings





You are allowed to set flash time, auto pause and dial mode here.

To Set Flash Time





1. Repeat 1-3 steps above;
2. Press Scrolling  button and Left  key to select *Dial Settings*;
3. Press Left  key to select *Flash Time*;
4. Press Scrolling  button and Left  key or just Left  key to select your preferred flash time (**Short, Long**).

To Set Auto Pause

When you call a number with a pause, the phone waits a few seconds before transmitting the next digits in the dialing sequence. This is useful when you have to dial a number for access to an outside line, or for going into a voicemail system. You are allowed to set one number in Auto Pause.







1. Press Scrolling  button and Left  key to select *Auto Pause* under *Dial Setting* mode;
2. Use the keypad to input the PIN (0000), press Left  key to confirm;
3. Use the keypad to input the number (for example “123”) you want to set auto pause, press Left  key to confirm. When you dial number “123456”, the pause will happen between “123” and “456”.







To Set Dial Mode

1. Press Scrolling  button and Left  key to select *Dial Mode* under *Dial Setting* mode;
2. Press Scrolling  button and Left  key or just press Left  key to select your preferred mode (**Pulse, Tone**).

To Set Call Barring





Call barring enables you to restrict or bar certain types of calls from your phone.

1. Press Scrolling  button and Left  key to select *Settings* under main menu mode;
2. Press Scrolling  button and Left  key to select *Cordless settings*;
3. Press Scrolling  button and Left  key to select *Base settings*;





4. Press Scrolling  button Left  key to select *Call Barring*;
5. Use the keypad to key in the PIN (0000), press Left  key to confirm;
6. Press Scrolling  button Left  key or just Left  key to select your preferred number to set call barring (up to 5 numbers);
7. Use the keypad to key in the number, press Left  key to confirm;

To Set LCR (Least Cost Route)



With the LCR function, the phone will automatically replace a long number with a comparative short number, to simplify the process of dialing a long number. For example, if the user program to replace "00" with "17909", then when he dials "006567417211", then the phone will automatically replace the number to be dialed out as "179096567417211".

1. Press Scrolling  button Left  key to select *LCR* under *Base Settings* mode;
2. Use the keypad to key the PIN (Default:0000), press Left  key to confirm;
3. Use the keypad to key in the SHORT number that you want to replace the long number, press Left  key to confirm;
4. Use the keypad to key in the LONG number, press Left  key to confirm.

To Change PIN

1. Press Scrolling  button Left  key to select *PIN* under *Base Settings* mode;
2. Use the keypad to key in the original PIN (0000), press Left  key to confirm;
3. Use the keypad to key in the new PIN you want to set, press Left  key to confirm.

Default Settings

1. Press Scrolling  button Left  key to select *Default* under *Base Settings* mode;
2. Use the keypad to key in the current PIN, press Left  key to confirm, then all features will return to their default settings.

■ Resetting the System

If you have set a PIN and forgotten it, you need to reset the system. The PIN will be reset to 0000. If you reset the system, you will lose all stored information (including numbers

in memory) and all features will return to their default settings. You need to register the handset to the base unit again.

While you are resetting the system, you should disconnect the telephone line cord from the back of the base unit, so you won't be interrupted by incoming calls. To reset the system without the PIN:







1. Disconnect the power lead from the back of the base unit
2. Press and hold the **HANDSET LOCATOR** button in the base unit, at the same time connect the power lead into the back of base unit. Release the **LOCATOR** button after you hear “beep” sound for five times. The IN USE light on base unit lights during this whole process.
3. After 2~3 seconds, you can hear “beep” sound for two times again and the IN USE light goes off;
4. Disconnect the power lead from base. Reconnect and you will hear a confirmation tone from the base unit.

■ Contacts

Your list of contacts contains all Skype users as well as all landline phone users that you have added. There is a limit to the number of entries you can make, but your contact list can nevertheless hold hundreds of contacts.

To Access your Contacts List

Press Right  key to access your contacts list in standby mode or











1. In standby mode, press Left  key to enter the main menu;
2. Press Scrolling  key and Left  key to select *Contacts*;
3. Browse your contacts using Scrolling  key, press Left  key to select one;
4. Press Scrolling  key and Left  key to select your desired action (**Call, Send voicemail, View profile, Advanced**)
5. Under *Advanced* you can access more options (Rename, Remove, Block, Request details, Add a contact).

To Exchange Contact Details Request





You can send an authorization request to a Skype user – and if it is accepted, you can see his or her online status.

When adding a contact to your Contact list you will be prompted to specify if you want to send an authorization request. We recommend that you send this request but you do not





have to do so –and you can send the request whenever you wish to. If you do not send the request, you will never be able to see the contact’s online status. Users who have not been authorized will be indicated by  on your contact list.

1. In standby mode, press Left  key to enter the main menu;
2. Press Scrolling  key and Left  key to select *Contacts*;
3. Browse your contacts using Scrolling  key, press Left  key to select one you still have not sent an authorization request;
4. Press Scrolling  key and Left  key to select *Advanced*;
5. Press Scrolling  key and Left  key to select *Request Details*;
6. Use the keypad to enter the text you want to send along with the request, press Left  key to send the authorization request.





To Rename a Contact

1. Press Scrolling  key and Left  key to select *Rename* under *Advanced* mode;
2. Use the keypad to enter the new name, press Right  key to clear the incorrect characters, press Left  key to confirm;

To Remove a Contact











1. Press Scrolling  key and Left  key to select *Remove* under *Advanced* mode;
2. Press Scrolling  key and Left  key or just Left  key to select your desired types of remove (**Remove and block contact, Remove only**).

To Block a Contact

- Press Scrolling  key and Left  key to select *Block* under *Advanced* mode. When you block the contact successfully, press Right  key to go back to the *Advanced* mode;
- To unblock the contact, press Left  key to select *Unblock* under current *Advanced* mode;

To Check Contacts Requests



1. In standby mode, press Left  key to enter the main menu;

2. Press Scrolling  key and Left  key to select *History*;
3. Press Scrolling  key and Left  key to select *Contacts Requests*;
4. Press Scrolling  key and Left  key or just Left  key to select the request you desire to check;
5. Press Left  key, the display shows you the options;
6. Press Left  key to accept or press Scrolling  key and Left  key to decline the request.

■ Handling Calls

To Make an Intercom Call





To make an intercom call, you must register at least two handsets to one same base.

1. Press the INT  key, you will hear Dial tone;
2. Key in the number of another handset. On the other handset's display, your number appears, and the **INT** symbol flashes. Then the other handset user presses the Call  key to connect the call.

Call Waiting

V500DS DECT has a Call Waiting feature that works with Caller ID service from your telephone service operator. When you're engaged on a PSTN ongoing call, if you receive a second Skype call, your phone will use a call waiting signal to let you know another call is ringing in. This way, you can switch between Skype and PSTN callers, hook down Skype call or even make Skype conference call together.







To Hold / Un-hold an Active Call

1. Press Left  key to enter option menu during an active call;
2. Press Scrolling  button and Left  key to select *Hold the call*, then the incoming call is on hold;
3. Press Left  key again to select *Unhold the call*, you can retrieve the call.

To Divert all Calls

You can configure your V500DS to forward all incoming Skype calls either to a landline/mobile phone or to your Voicemail. Please note that in order to use this function, you have to have Skype credits.

1. In standby mode, press Left  key to enter the main menu;

2. Press Scrolling  key and Left  key to select *Settings*;
3. Press Scrolling  key and Left  key to select *Call divert*;
4. Press Scrolling  key and Left  key to select your desired action (**Call forwarding, Forward to, Voicemail, Welcome message**)

Call forwarding: Activate forwarding to another phone number. You will be prompted to enter the relevant number, which can be both a Skype name and an ordinary extension number. Please remember to enter the country code.

Forward to: Edit the phone number when **call forwarding** is active.

Voicemail: Activate your Voicemail, allowing callers to leave a message after listening to your welcome message.

Welcome message: After activating **voicemail** you can record your welcome message. If you do not record a personal message, the Skype standard message will be used instead.

Skype conference call

The V500DS cannot initiate a Skype conference call, but you can participate in a Skype conference call initiated from a computer.

The operation is similar to Answer a call. (Refer to **To Answer a call** section for more details)

If the active call is a Skype conference call, you can see the participants via the **View Participants** menu.

Troubleshooting

Always check first that:

- You have followed the steps listed on pages to install and set up your V500DS.
- All connects are firmly inserted in their sockets.
- Mains power is switched on at the socket.

- The handset's batteries are correctly and securely installed, and are not run down.

If you experience difficulties with the working of your V500DS, refer to the advice given below.

I cannot make or answer calls.

- Check that the base unit's mains power adapter is plugged in and power is switched on. The base unit needs mains power for normal operation of the phone-not just charging the batteries.
- Make sure you are using the telephone line cable that was supplied with your V500DS. Other telephone line cables might not work.
- Move the handset closer to the base unit.
- Check the batteries level symbol on the display. If it is low, replace the handset on the base unit or charger pod to recharge the batteries.
- Switch off power at the mains socket, wait for a few seconds and then switch back on. This may solve the problem.
- If you still can't make calls, try re-registering the handset.

When I place Skype call, there is no sound.

- Check the network.

I cannot enter Skype Contact List

Check that the Ethernet cable between  on the base station and the LAN port on your broadband connection (modem, router, hub, switch etc.) is connected properly.

When I press keys on the handset, nothing happens.

- Make sure the batteries are fitted in your handset. If the batteries level symbol on the display shows "low", recharge the batteries.
- Check whether there's a key symbol on the display. If so, the keypad is locked. Turn to the user manual to find out how to unlock it.

When I press keys on the handset, digits appear on the display, but I can't make an outside call.

- Try moving the handset closer to the base unit.
- Try a different position for the base unit-perhaps higher, or further from other electrical equipment.

The phone does not ring

- Check that the base unit's mains power adapter is plugged in and power is switched on. The base unit needs mains power for normal operation of the phone-not just charging the batteries.
- Make sure you are using the telephone line cable that was supplied with your V500DS. Other telephone line cables might not work.
- Check that you have set the ringer volume to off. See the user manual for more information.
- Check that the total REN value of all equipment connected to your telephone line is no more than 3. Disconnect one or more telephones and see whether that helps.

The base does not ring.

- Check that the base power is ON, and the base ringer is set ON.
- Check that the line cord is correctly fitted and undamaged.

The CHARGE light on the base unit does not come on.

- Check the handset is properly stationed.
- Check the connections between the base unit and mains power socket.
- Clean the batteries charging contacts with a dry cloth.

When I press the CALL button, I hear a loud noise.

- The strange noise is caused by interference. Disconnect the mains power lead from the back of the base unit, and then wait for 30 seconds before reconnecting it.

There is 'beep' sound while I am on a call.

- You may be going out of range of the base unit. Move closer, or your call may be cut off.
- Check the Batteries Level symbol on the display. If it is low, recharge the batteries.

The Caller Display feature isn't working.

- You need to subscribe to the Caller Display feature from your service provider.
- The caller may have withheld their number, or they may be calling from a network that does not transmit the Caller ID (for example, it may be an international call).

The handset's batteries are running low within an hour or two.

- Before you used the handset for the first time, you should have left it on the base unit for up to 15 hours to charge the batteries fully.

- You may need to replace the batteries.

I cannot transfer a call.

- Make sure the other handset is within range of the base unit, and is not busy on a call.
- Make sure you are keying in the correct number for the other handset.

No display on LCD screen.

- Make sure the batteries have power.

I cannot register handset to base

- Make sure the number of handset registered to base is less than 4.
- Check that the base unit is not near other electrical equipment, such as TV or computer

Technical Details

Full DECT GAP Compatible system

Standard	Digital Enhanced Cordless Telecommunications (DECT)
Frequency range	1.8 GHz / 2.4 GHz
Channel bandwidth	1.728 MHz

Modulation	GFSK
Operating range	Up to 300 m outdoors; Up to 50 m indoors
Operating time	Standby time: 120 hours Talking time: 8 hours
Temperature range	Operating 0 ⁰ C to 40 ⁰ C Storage -20 ⁰ C to 60 ⁰ C
Electrical power	Handset--- 2 x 1.2 V 750 mAh Ni-MH, Rechargeable battery cell Base unit---Input 230 V AC, 50 Hz Output DC 9 V, 500 mA.
PABX compatibility	Timed break recall: 100 ms for short flash; 250 ms for long flash Pause length: 3 seconds Signaling type: DTMF (dual-tone multifrequency) Pulse dialing
Humidity	10%~70%(non-condensing)

Declaration of Conformity

The V500DS complies with the essential protective requirements and objectives of:

- EC R& TTE Directive 1999/5/EC
- EC Low Voltage Directive 73/23/EEC
- EC EMC Directive 89/336/EEC

And conforms to the following relevant harmonized standards:

- TBR 10:1999
- TBR 22:1997
- TBR 38:1998
- EN 301406 V1.5.1:2003
- EN 301437 V1.1.1:1999
- EN 301489-01 V1.4.1:2002
- EN 301489-06 V1.2.1:2002
- EN 60950-1:2001